

What's Included

- Clubhouse Backrest
- Backrest Hinge
- Fastening Strap, 50 x 185 mm

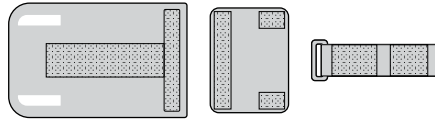

⚠ Attention

- Keep Backrest away from sharp objects.
- Store Backrest away from direct sunlight when not in use to extend its lifespan.

Installation

⚠ Clubhouse Seat Pad and either Clubhouse, Clubhouse+, or Clubhouse Mini are required for Backrest installation.

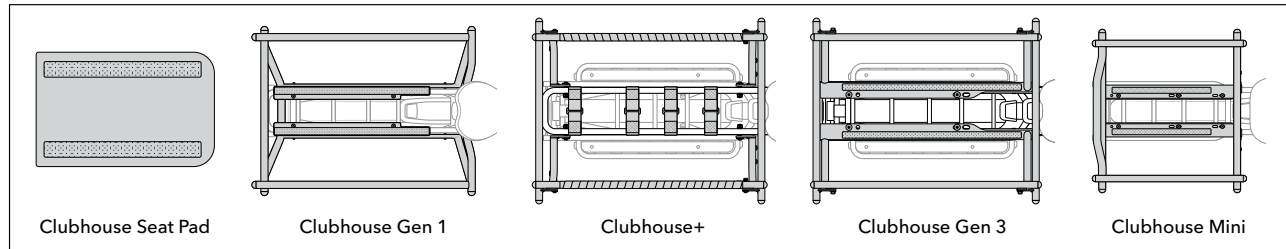

Position Fastening Strap on center of Rear Bar.

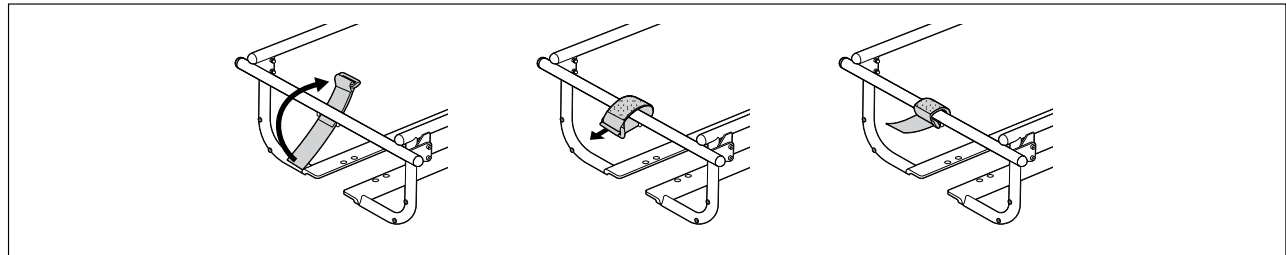

Join Clubhouse Backrest and Seat Pad with Backrest Hinge.

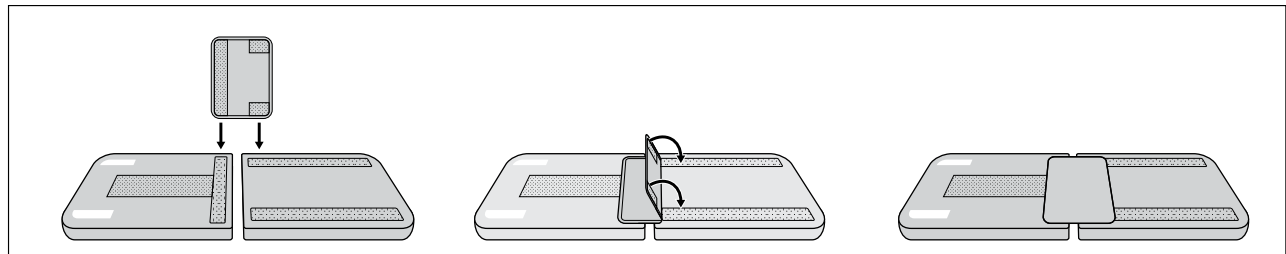

Align velcro and press firmly.

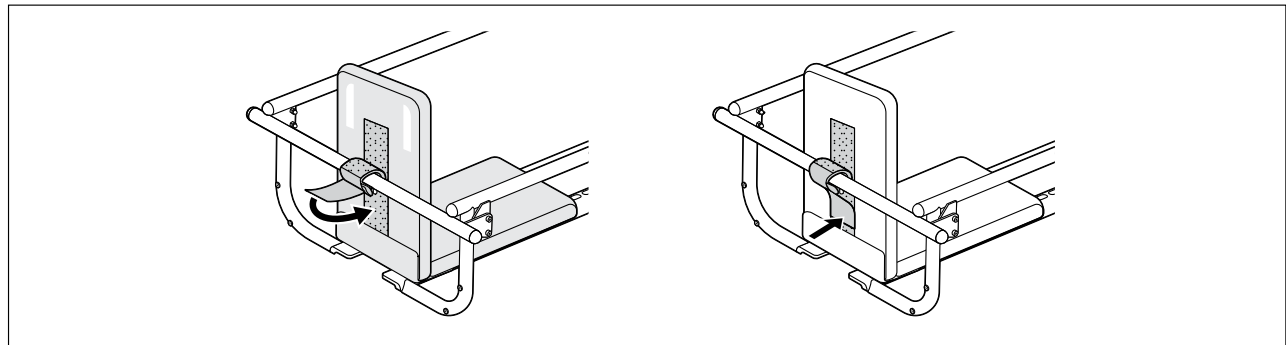

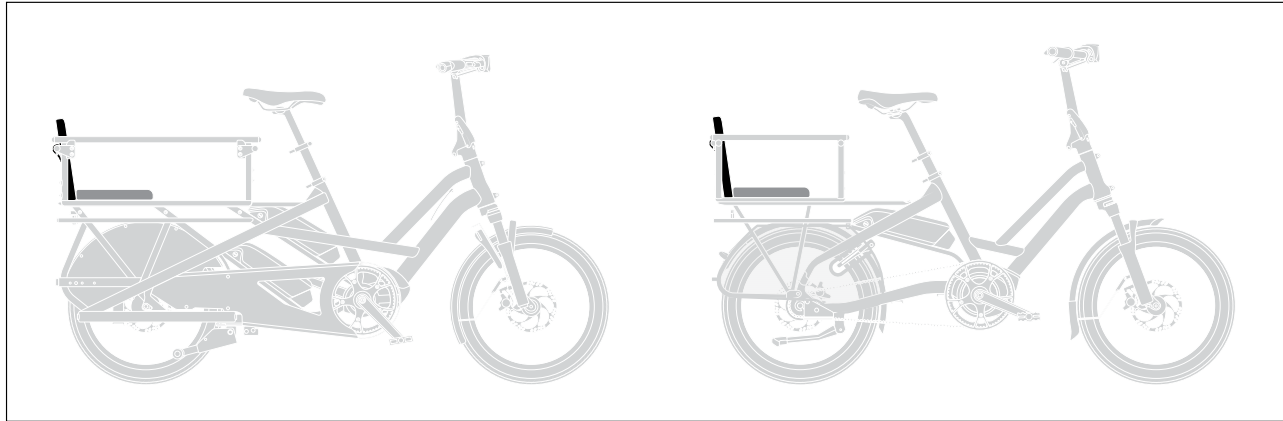

Visit <https://www.ternbicycles.com/en/support> to download the latest manual.

LIMITED PRODUCT WARRANTY INFORMATION: This Product comes with a ONE (1) YEAR Limited Warranty from the date of retail purchase by the original end-user. If a material or workmanship defect arises and a valid claim is received within the Warranty Period, this Product will be replaced. Mobility Holdings cannot be held liable for damages to personal property due to misuse or improper care and maintenance. This Product Warranty does not, under any circumstance, cover the replacement or cost of any third party product used with or connected to the Product.

Tern, the Tern Werd (logotype), the Tern Berd (device), GSD and Clubhouse used alone or in combination are trade names, trade devices or registered trademarks of Mobility Holdings, Ltd.

© 2023. Tern is a trademark of Mobility Holdings, Ltd. All Rights Reserved.

   @ternbicycles

[ternbicycles.com](https://www.ternbicycles.com)

Carrying Rear Passengers

In order to safely transport rear passengers, please check the following points and ensure your bike is equipped with the proper accessories.

Check Local Regulations

⚠ It may be illegal to carry passengers on a bike in your area even if it has been designed or configured to do so. Check your local regulations before carrying passengers.

Check Max Gross Vehicle Weight Limits

⚠ Please follow and check your bike's manual for information about maximum gross vehicle weight. (*Maximum gross vehicle weight is the total weight of the bike, rider, passenger, accessories, and cargo.*) Most riders can comfortably carry 80% of their weight. You should determine if you are comfortable carrying that much weight.

Wear a Helmet

Rider and rear passenger(s) are strongly advised to wear an approved helmet.

Do NOT Leave Children Unattended

Do not allow your children to climb onto the bike nor leave your children unattended on the bike, even if it is on the kickstand. Wriggling children can upset the balance of the bike and a fall may result in serious injuries.

Use Proper Equipment

⚠ The bike needs to have the following accessories installed in order to safely transport rear passenger(s).

- | | |
|--|--|
| <p>1. Seating. Purpose-built rear seating, chosen according to the passenger's needs</p> | <p>3. Foot support. Fixed platforms or dedicated footrests on both sides of the bike</p> |
| <p>2. Handhold. Something for the passenger to hold on to, other than the bike itself</p> | <p>4. Foot and leg protection. Something to prevent feet and legs from getting caught in the spinning wheel</p> |

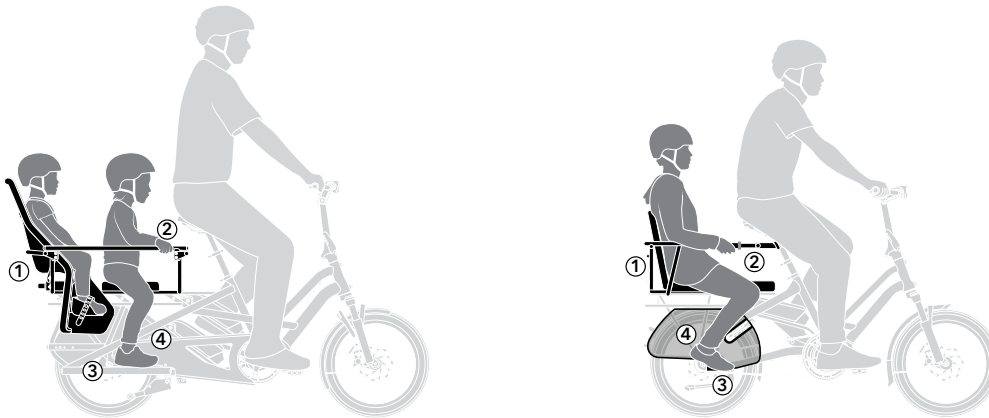

The illustrations above show a mix of suggested gear to safely carry passengers. Your combination of passenger accessories may differ depending on your needs. To learn more about to safely carry passengers on your bike, visit ternbicycles.com/support.

Follow Installation Procedures

Check to ensure accessories have been correctly installed and securely fastened before riding.

Use Accessories Properly

Our seating accessories are strictly for sitting. Using them to lift the bike will damage the frame and accessory.

Our rear handhold accessories are strictly for passengers to hold. Adding substantial weight on the top of or using the rear passenger handlebars to lift the bike will cause undue stress on the seatpost and handlebar.

Our foot support accessories are strictly for passenger use when SEATED. Standing on them is unsafe and may permanently damage the frame.



Scan to view available passenger seating accessories